

## Reggimensola registrabili tipo MN113 Adjustable shelf support type MN113

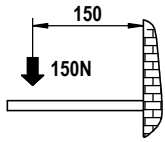

PER UNA REGGIMENSOLA  
LOADING CAPACITY FOR PIECE

CARATTERISTICHE FONDAMENTALI:  
DOPPIA REGOLAZIONE  
"A" ORIZZONTALE E VERTICALE.  
"B" INCLINAZIONE.  
"C" POSSIBILITA' DI AVVITARE UN GRANO NELLA GOLA PER EVITARE LO SFILAMENTO DELLA MENSOLA. SI CONSIGLIA DI FARE LE REGOLAZIONI APPOGGIANDO LA MENSOLA SUI REGGIMENSOLA, E UNA VOLTA ESEGUITE LE REGOLAZIONI INFILARE LA MENSOLA NELLE OPPORTUNE SEDI.

GENERAL ADVANTAGES:  
DOUBLE ADJUSTMENTS  
"A" HORIZONTAL AND VERTICAL  
"B" INCLINATION  
"C" POSSIBILITY TO INSERT A GRAIN FOR ANTI-DROP SYSTEM. WE SUGGEST TO ADJUST BY LOCATING THE SHELF UPON THE SUPPORTS, AND INSERT IT AFTER THE ADJUSTMENTS.



DISPONIBILI TASSELLI PER CARTONGEZZO  
AVAILABLE FOR DRYWALL ANCHORS

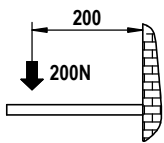

PER UNA REGGIMENSOLA  
LOADING CAPACITY FOR PIECE

CARATTERISTICHE FONDAMENTALI:  
DOPPIA REGOLAZIONE  
"A" ORIZZONTALE E VERTICALE.  
"B" INCLINAZIONE.  
"C" POSSIBILITA' DI AVVITARE UN GRANO NELLA GOLA PER EVITARE LO SFILAMENTO DELLA MENSOLA. SI CONSIGLIA DI FARE LE REGOLAZIONI APPOGGIANDO LA MENSOLA SUI REGGIMENSOLA, E UNA VOLTA ESEGUITE LE REGOLAZIONI INFILARE LA MENSOLA NELLE OPPORTUNE SEDI.

GENERAL ADVANTAGES:  
DOUBLE ADJUSTMENTS  
"A" HORIZONTAL AND VERTICAL  
"B" INCLINATION  
"C" POSSIBILITY TO INSERT A GRAIN FOR ANTI-DROP SYSTEM. WE SUGGEST TO ADJUST BY LOCATING THE SHELF UPON THE SUPPORTS, AND INSERT IT AFTER THE ADJUSTMENTS.

acciaio - zama  
steel - die-cast

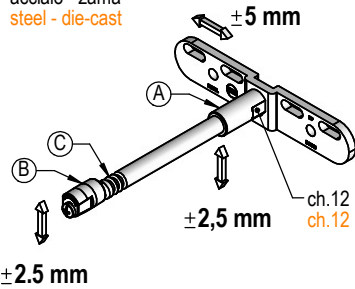

±2.5 mm

fori Ø6.5 per tasselli chimici  
6.5 mm hole for chemical fishers

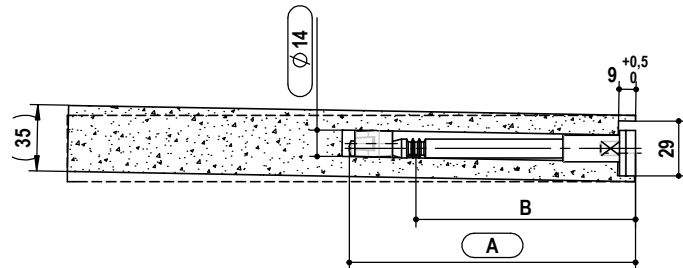
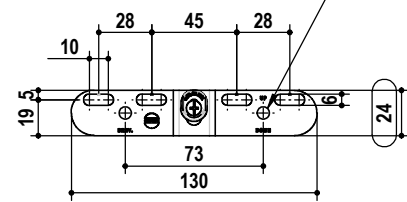

| tipo   | misura  | A   | B   | finitura                     | box | kg / box |
|--------|---------|-----|-----|------------------------------|-----|----------|
| type   | measure |     |     | finishing                    |     |          |
| MN113. | 120.    | 120 | 75  | 02 zincato bianco white zinc | 100 | 16,8     |
|        | 150.    | 150 | 105 |                              |     | 18,2     |
|        | 175.    | 175 | 130 |                              |     | 19,8     |

es./e.g.: MN113.150.02

## Reggimensola registrabili tipo MN114 Adjustable shelf support type MN114

acciaio - zama  
steel - die-cast

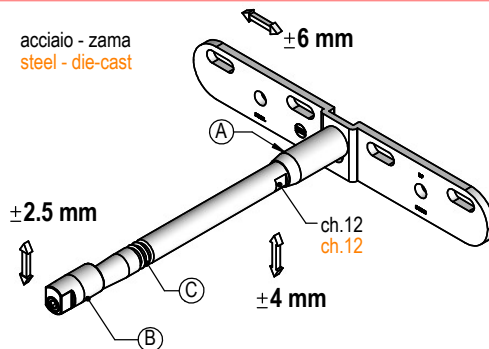

±2.5 mm

fori Ø8.5 per tasselli chimici  
8.5 mm hole for chemical fishers

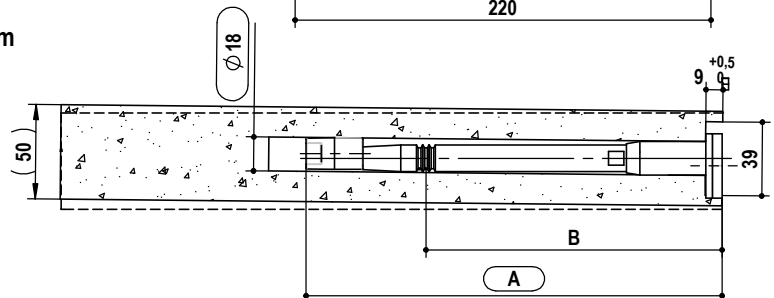
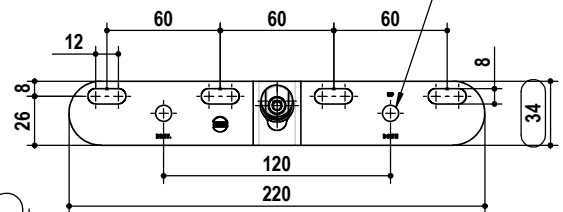

| tipo   | misura  | A   | B   | finitura                     | box | kg / box |
|--------|---------|-----|-----|------------------------------|-----|----------|
| type   | measure |     |     | finishing                    |     |          |
| MN114. | 220.    | 220 | 145 | 02 zincato bianco white zinc | 25  | 26,2     |
|        | 350.    | 350 | 175 |                              |     | 32       |

es./e.g.: MN114.350.02